



EN

TUE-T252TX

TV TUNER/DIVERSITY UNIT

DE

- **OWNER'S MANUAL**
Please read before using this equipment.
- **BEDIENUNGSANLEITUNG**
Lesen Sie diese Bedienungsanleitung bitte vor Gebrauch des Gerätes.
- **MODE D'EMPLOI**
Veuillez lire avant d'utiliser cet appareil.
- **MANUAL DE OPERACIÓN**
Léalo antes de utilizar este equipo.
- **ISTRUZIONI PER L'USO**
Si prega di leggere prima di utilizzare l'attrezzatura.
- **ANVÄNDARHANDLEDNING**
Innan du använder utrustningen bör du läsa igenom denna användarhandledning.
- **ТВ ТЮНЕР/МНОГОФУНКЦИОНАЛЬНОЕ УСТРОЙСТВО**
Пожалуйста, прочитайте руководство перед использованием оборудования

FR

ES

IT

ALPINE ELECTRONICS GmbH
Frankfurter Ring 117
80807 München, Germany
Tel. 089-3242640

ALPINE ELECTRONICS MARKETING, INC.
1-1-8 Nishi Gotanda,
Shinagawa-ku,
Tokyo 141-0031, Japan
Tel. 03 5496-8231

ALPINE ELECTRONICS OF AMERICA, INC.
19145 Gramercy Place, Torrance,
California 90501, U.S.A.
Tel. 1-800-ALPINE-1 (1-800-257-4631)

ALPINE ELECTRONICS OF CANADA, INC.
7300 Warden Ave., Suite 203, Markham,
Ontario L3R 9Z6, Canada
Tel. 1-800-ALPINE-1 (1-800-257-4631)

ALPINE ELECTRONICS OF AUSTRALIA PTY. LTD.
6-8 Fiveways Boulevard Keysborough,
Victoria 3173, Australia
Tel. 03 9769-0000

ALPINE ITALIA S.p.A.
Viale C. Colombo 8, 20090 Trezzano Sul
Naviglio (MI), Italy
Tel. 02-48 47 81

ALPINE ELECTRONICS (Benelux) GmbH
Leuvensesteenweg 510-B6
1930 Zaventem, Belgium
Tel. 02-7251315

ALPINE ELECTRONICS FRANCE S.A.R.L.
(RCS PONTOISE B 338 101 280)
98, Rue De La Belle Etoile, Z.I. Paris Nord II
B P. 50016, 95945, Roissy Charles De Gaulle
Cedex, France
Tel. 01-48638989

ALPINE ELECTRONICS OF U.K. LTD.
Alpine House
Fletchamstead Highway, Coventry CV4 9TW, U.K.
Tel. 0870-33 33 763

ALPINE ELECTRONICS DE ESPAÑA, S.A.
Portal De Gamarra 36, Pabellón, 32
01013 Vitoria (Alava)-APDO 133, Spain
Tel. 945-283588

SE

RU

Contents

Operating Instructions

WARNING

WARNING	2
CAUTION	2
PRECAUTIONS	3
Controls on remote control	4
Battery Replacement	5

Basic Operations

Connection	6
Turning Power On and Off	7
Selecting the Source	7
Station Setup	8, 9, 10, 11

Information

In Case of Difficulty	12
Specifications	12

Installation and Connections

Warning	13
Caution	13
Precautions	14
Preparation	15
Installation	15
System Wiring Diagram	17

WARNING

WARNING

This symbol means important instructions. Failure to heed them can result in serious injury or death.

DO NOT OPERATE ANY FUNCTION THAT TAKES YOUR ATTENTION AWAY FROM SAFELY DRIVING YOUR VEHICLE.

Any function that requires your prolonged attention should only be performed after coming to a complete stop. Always stop the vehicle in a safe location before performing these functions. Failure to do so may result in an accident.

DO NOT DISASSEMBLE OR ALTER.

Doing so may result in an accident, fire or electric shock.

USE THIS PRODUCT FOR MOBILE 12V APPLICATIONS.

Use for other than its designed application may result in fire, electric shock or other injury.

KEEP SMALL OBJECTS SUCH AS BATTERY OUT OF THE REACH OF CHILDREN.

Swallowing them may result in serious injury. If swallowed, consult a physician immediately.

USE THE CORRECT AMPERE RATING WHEN REPLACING FUSES.

Failure to do so may result in fire or electric shock.

CAUTION

This symbol means important instructions. Failure to heed them can result in injury or material property damage.

HALT USE IMMEDIATELY IF A PROBLEM APPEARS.

Failure to do so may cause personal injury or damage to the product. Return it to your authorized Alpine dealer or the nearest Alpine Service Center for repairing.

DO NOT MIX NEW BATTERIES WITH OLD BATTERIES. INSERT WITH THE CORRECT BATTERY POLARITY.

When inserting the batteries, be sure to observe proper polarity (+ and -) as instructed.

Rupture or chemical leakage from the battery may cause fire or personal injury.

PRECAUTIONS

Temperature

Be sure the temperature inside the vehicle is between +45°C (+113°F) and 0°C (+32°F) before turning your unit on.

Fuse Replacement

When replacing the fuse(s), the replacement must be of the same amperage as shown on the blown fuse or fuse holder. If the fuse(s) blows more than once, carefully check all electrical connections for shorted circuitry. Also have your vehicle's voltage regulator checked.

Maintenance

If you have problems, do not attempt to repair the unit yourself. Return it to your Alpine dealer or the nearest Alpine Service Station for servicing.

Installation Location

Make sure the TUE-T252TX will not be exposed to:

- Direct sun and heat
- High humidity
- Excessive dust
- Excessive vibrations

Controls on remote control

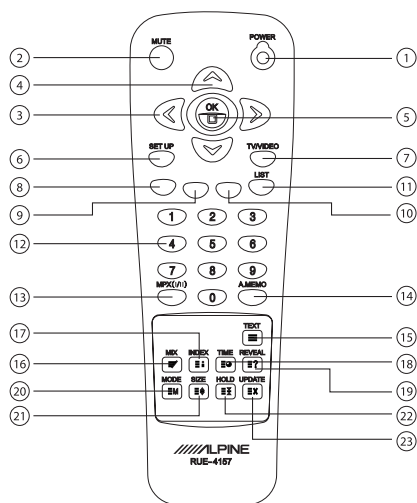

- 1 Power button**
Press the button to turn the TV tuner unit power on/off.
- 2 MUTE button**
Press the button to switch on/off the audio output.
- 3 < > Left / Right button**
Press left/right button to adjust the output volume. In the menu mode, press left/right to change to another menu or to alter settings.
- 4 ^ v Up / Down button**
Press up/down button to select a preset channel. In the menu mode, press up/down to navigate a menu or to alter settings.
- 5 OK button**
Press OK to show the current channel information. In the menu mode, press OK to enter a selected menu or to confirm a changed setting.
- 6 SETUP button**
Press setup button to enter/leave the setup menu.
- 7 TV/VIDEO button**
Press the TV/VIDEO button to select between sources (TV and AUX input).
- 8 Red Color button**
Press red color button to proceed an automatically assigned teletext function or to delete a channel in the programme edit menu.
- 9 Green Color button**
Press green color button to proceed an automatically assigned teletext function or to copy a channel in the programme edit menu.
- 10 Yellow Color button**
Press yellow color button to proceed an automatically assigned teletext function or to move a channel in the programme edit menu.
- 11 Blue Color button**
Press blue color button to proceed an automatically assigned teletext function or to skip a channel in the programme edit menu.
- 12 Number buttons**
Preset channels and teletext pages can be directly accessed by using the number buttons.
- 13 MPX(I/II) button**
Press MPX(I/II) button to select the audio signal when a dual channel or stereo service is received.
- 14 A.MEMO button**
Press A.MEMO (shortcut-) button to start the automatic channel search.
- 15 TEXT button**
Press TEXT button to switch on/off the teletext window.
- 16 MIX button**
Press MIX button to switch the background of the teletext window between black and transparent.
- 17 INDEX button**
Press INDEX button to select the default teletext INDEX page.
- 18 SUB-PAGE / TIME button**
Press the button to show the teletext time information in TV mode or to select a sub page in teletext mode if available.
- 19 REVEAL button**
Press REVEAL button to show the concealed information of a teletext page, such as riddle solutions etc.
- 20 MODE button**
Press MODE button to select the between the available teletext modes (FLOF, TOP, SIMPLE). The corresponding functions will be assigned to the color buttons.
- 21 SIZE button**
Press SIZE button to double/half the content size of the current teletext page.
- 22 HOLD button**
Press HOLD button to hold the page content of the current teletext page.
- 23 UPDATE button**
Press UPDATE button to update the page content of the current teletext page.

Battery Replacement

Applicable battery : Use two "AAA" sized dry batteries or equivalent.

- 1** Opening the battery cover
Slide out the battery cover while firmly pressing outward.

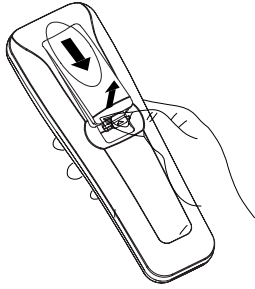

- 2** Replacing the battery
Put the batteries in the case observing the polarities as illustrated.

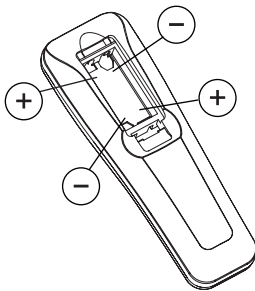

- 3** Closing the cover
Push the cover as illustrated until a click is heard.

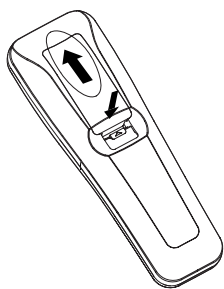

Basic Operations

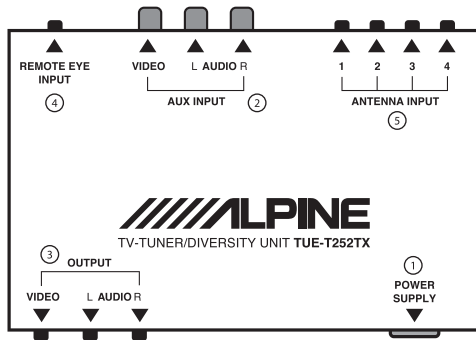

1. POWER CONNECTOR

- ① **ACC / IGNITION lead (red):**
12V switched power from the vehicle.
- ② **GROUND lead (black):**
Chassis power ground from the vehicle.
- ③ **REMOTE IN lead (white/brown):**
Connect this lead to the remote output signal lead of an external monitor device or headunit.
- ④ **PARKING BRAKE lead (yellow/blue):**
Connect this lead to the parking brake signal of the vehicle. After the parking brake is released "SCREEN OFF FOR YOUR SAFETY" is displayed for four seconds before the device switches off automatically.

2. AUX INPUT

A/V: RCA input jacks for auxiliary source.

3. OUTPUT

A/V: RCA output jacks.

4. REMOTE EYE INPUT

External IR remote sensor connection jack.

5. ANTENNA INPUT

Quad diversity antenna connection jacks.

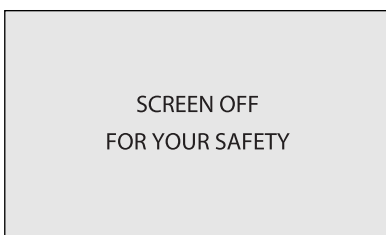

Display after parking brake was released.

Basic Operations

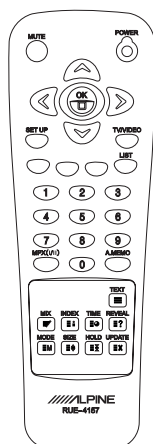

Turning Power On and Off

1. Turn on the monitor device and make sure the input connected to TUE-T252TX is selected.
2. Press the POWER button on the remote control to switch TUE-T252TX on and off.

Selecting the Source

Press the TV / VIDEO button to change the output signal from TV to AUX and vice versa.

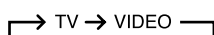

TV Area List

Area No.	Indication Mode	TV System	VHF CH	UHF CH	Country
1	PAL-1	PAL B·G/H	02 to 12 ch	21 to 69 ch	A, B, CH, D, DK, E, FIN, N, NL, P, S
2	PAL-2	PAL B·G	A to H2 ch	21 to 69 ch	I
3	PAL-3	PAL I·I	A to J ch	21 to 69 ch	GB, IRL, HK
4	SECAM-1	SECAM L	—	21 to 69 ch	F
5	SECAM-2	SECAM D·K	R1 to R12 ch	21 to 69 ch	BG, CZ, H, PL, RUS
6	SECAM-3	SECAM B·G	02 to 12 ch	28 to 69 ch	GR, RO
7	PAL-4	PAL B·H	0 to 12 ch	21 to 69 ch	AUS
8	PAL-5	PAL B·G	01 to 12 ch	21 to 69 ch	NZ
9	PAL-6	PAL B·G	01A to 11 ch	21 to 69 ch	RI
10	PAL-7	PAL B·G	02 to 12 ch	21 to 69 ch	IND, MAL
11	PAL-8	PAL I·I	04 to 13 ch	21 to 69 ch	ZA

Basic Operations

Station Setup

Press the SETUP button on the remote control to enter the OSD setup menu.

Then select the channel icon (CH) in the left column to get to the station settings.

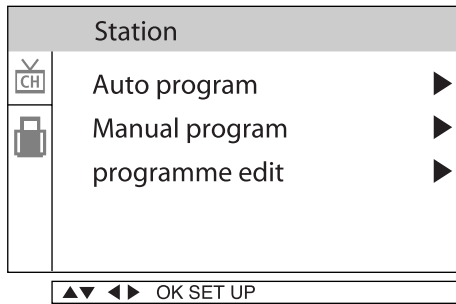

Select the desired sub menu by using the arrow buttons on the remote control.

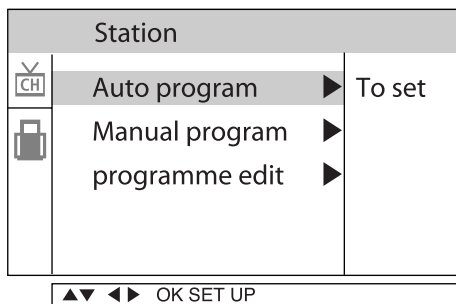

Auto Programme:

In this sub menu the automatic channel seek can be set up and activated.

Manual Programme:

In this sub menu channels can be adjusted and named manually.

Programme edit:

In this sub menu previously stored channels can be edited.

Auto Programme

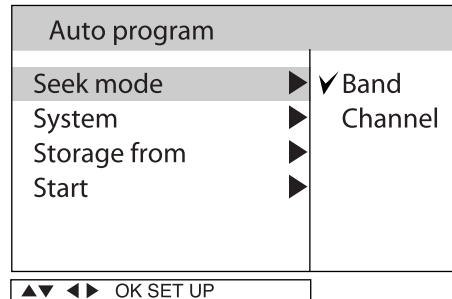

Select the desired seek mode.

Band:

During the automatic channel seek the entire frequency band is searched for TV stations (slower).

Channel:

During the automatic channel seek only the frequencies of known TV channels are searched for available TV stations (faster).

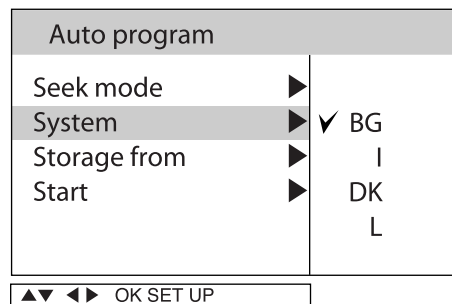

Select the TV standard broadcasted in your country (BG, I, DK, L).

Please refer to the area list on page 7, if you are not aware of the standard in your area.

Basic Operations

Station Setup

Auto program	
Seek mode	▶
System	▶▶
Storage from	▶▶▶ 00
Start	▶▶▶

▲▼ ◀▶ OK SET UP

Storage from :

Select the desired preset channel start number. During the automatic channel seek found stations will be stored from the selected preset channel number onwards.

Auto program	
Seek mode	▶
System	▶▶
Storage from	▶▶▶
Start	▶▶▶ To Start

▲▼ ◀▶ OK SET UP

Start :

Select Start to activate the automatic channel seek.

Auto program	
C 25(BG)	
P02	65%
	

▲▼ ◀▶ OK SET UP

The A.MEMO button on the remote control provides a short cut for starting the automatic channel seek.

Manual Programme

Manual program	
Storage	▶▶▶ 00
System	▶▶▶
Channel	▶▶▶
Fine	▶▶▶
Search	▶▶▶
Name	▶▶▶

▲▼ ◀▶ OK SET UP

Storage:

Select a desired preset channel number between 0 and 99 a TV station should be manually stored to.

Press the left/right arrow buttons or numeric keys on the remote control to edit this value.

Basic Operations

Station Setup

Manual program	
Storage	▶
System	▶ ✓ BG
Channel	▶ I
Fine	▶ DK
Search	▶ L
Name	▶

▲▼ ◀▶ OK SET UP

System:

Select the TV standard broadcasted in your country (BG, I, DK, L).

Please refer to the area list on page 7, if you are not aware of the standard in your area.

Manual program	
Storage	▶
System	▶
Channel	▶ ✓ V/UHF 3 Cable
Fine	▶
Search	▶
Name	▶

▲▼ ◀▶ OK SET UP

Channel:

To enter a channel number manually, select "VHF/UHF" for terrestrial and "Cable" for cable channel numbers first. Then enter the desired channel number by using the numeric keys on the remote control.

Manual program	
Storage	▶
System	▶
Channel	▶
Fine	▶ ◀▶
Search	▶
Name	▶

▲▼ ◀▶ OK SET UP

Fine:

A manual fine tuning of the currently received station can be done by pressing the left/right arrow buttons on the remote control.

Left arrow button: Freq. down.

Right arrow button: Freq. up.

Manual program	
Storage	▶
System	▶
Channel	▶
Fine	▶
Search	▶ ◀▶
Name	▶

▲▼ ◀▶ OK SET UP

Search:

A manual channel search can be done by pressing the left/right arrow buttons on the remote control.

Left arrow button: Freq. down.

Right arrow button: Freq. up.

Manual program	
Storage	▶
System	▶
Channel	▶
Fine	▶
Search	▶
Name	▶ V 03

▲▼ ◀▶ OK SET UP

Name:

The currently selected preset station can be manually named with 5 characters.

Basic Operations

Station Setup

Programme Edit

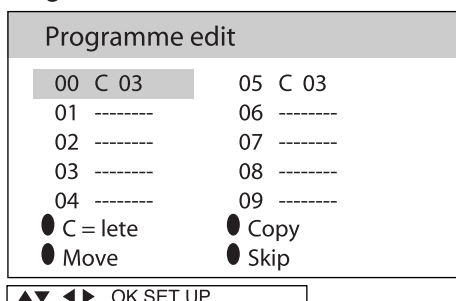

In this sub menu the preset channel list can be manually arranged.

Channels can be copied, deleted, moved or skipped.

Red RC button

erases the highlighted preset channel number.

Green RC button

copies the selected channel to the highlighted position.

Yellow

moves the selected preset channel number to the highlighted position.

Blue

skips the highlighted preset channel if selected by using the up/down arrow buttons on the RC.

Special Settings

Select the lower menu icon in the left column to get to the special settings.

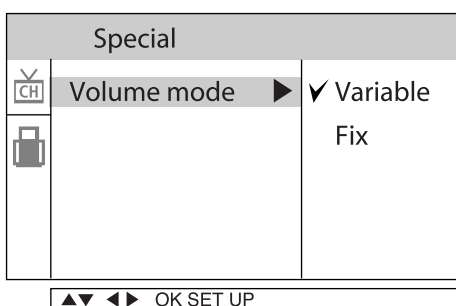

Volume Mode

Variable:

The volume level can be adjusted by using the left/right arrow buttons on the remote control.

Fix:

The volume is fixed at its current level and cannot be changed until "variable" is selected again.

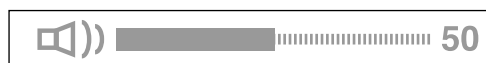

In "fix" mode the above volume bargraph does not appear on the screen, although the left/right arrow buttons on the RC are pressed.

Programme List

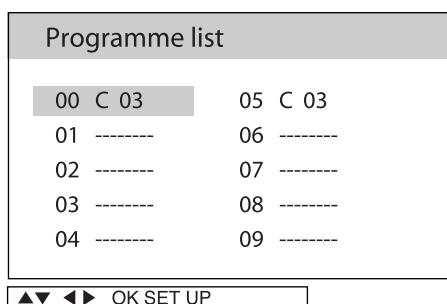

Press the LIST button on the remote control to show the current preset channel list.

Stations can be directly selected from this list.

Information

In Case of Difficulty

If you encounter a problem, please review the items in the following checklist. This guide will help you isolate the problem if the unit is at fault. Otherwise, make sure the rest of your system is properly connected or consult your authorized Alpine dealer.

No power supplied.

- Vehicle's ignition is off.
 - Turn the ignition on.
- No fuse or blown fuse.
 - Check the cause and replace the fuse.
- Incorrect connections.
 - Check connection and remedy.
- Vehicle's battery is weak.
 - Check the voltage of vehicle's battery.

Remote control does not work.

- Battery is worn out.
 - Replace battery.
- Incorrect battery insertion.
 - Insert battery correctly.
- Remote control does not point remote control sensor.
 - Operate remote control so that it faces the sensor.
- Remote control sensor or remote control transmitter window is dirty.
 - Clean remote control sensor or transmitter window.

Picture not clear or noises appear.

- Poor signal strength.
- Out of service area of station being received.
 - Check by moving car in other location.

No picture obtained.

- TV/VIDEO switch is not set to a desired mode.
 - Select desired mode by pressing TV/VIDEO button.
- Temperature inside car is high.
 - Lower the temperature.
- Poor connections between monitor and tuner.
 - Check connections.

Dots or stripes appear on picture.

- Affected from neon sign, high voltage line, amateur radio transmission, cars, etc.
 - Move car to a location free from interference.

Double or triple pictures or rolling picture appear.

- Signals are reflected by mountain or buildings near car.
 - Move car to other locations. Adjust location, direction and height of antenna.

Noises appear in car radio.

- High frequency signals from TV are received by car radio.
 - Keep away antenna leads and other wire leads from TV.

Too much voice noise is heard.

- TV area is improper.
 - Confirm the setting for a TV area.

Audio interruption function does not work in combination with navigation system.

- TV channel 56 is received.
 - Switch channel other than 56.
- Poor connection of guide control input cord.
 - Connect guide control cord of navigation securely.

Channel display is incorrect.

- The field strength is low.
 - Move the car to other location and check it again.

Picture becomes whitish.

- Located under a TV tower.
 - Move the car to other location to use it.
 - If you want to use in that location, turn the TV antenna's booster switch to off position, if applicable.

Specifications

TV Tuner

Color System PAL/SECAM
Channel Selection System PLL Frequency Synthesizer System
Channel Coverage

Television System	CH	PAL-B/G	PAL-I/I	SECAM-L	SECAM-D/K	SECAM-B/G
Channel Coverage	VHF	2~12 ch	A~J ch	-	1~12 ch	2~12 ch
		A~H2 ch	-	-	-	-
	UHF	21~69 ch				

* As for TV area 7 to 11, refer to the TV area list on page 6.

Antenna Input ... 4-channel diversity (75 ohms, 3.5 ϕ mini-jack)
Maximum Sensitivity (-6 dB Output) ... 35 dB μ (at 471 MHz)
Video/Audio S/N (75 dB μ) 45 dB/50 dB
Video Output System PAL
Video Output Level 1.0p-p/75 ohms
Audio Output Level 500mV/10k ohms

General

Operating Voltage DC14.4V (11 to 16V)
Operating Current 600mA
Operating Temperature Range -10°C ~ +60°C
Storage Temperature Range -20°C ~ +80°C
Dimensions (mm) 189 (W) x 116 (D) x 28 (H)

TV Antenna Unit

Output Impedance 75 ohms, 3.5 ϕ mini-jack
Operating Temperature Range -10°C ~ +60°C

Installation and Connections

Before installing or connecting the unit, please read the following and pages 2 and 3 of this manual thoroughly for proper use.

Warning

MAKE THE CORRECT CONNECTIONS.

Failure to make the proper connections may result in fire or product damage.

USE ONLY IN CARS WITH A 12 VOLT NEGATIVE GROUND.

(Check with your dealer if you are not sure.) Failure to do so may result in fire, etc.

BEFORE WIRING, DISCONNECT THE CABLE FROM THE NEGATIVE BATTERY TERMINAL.

Failure to do so may result in electric shock or injury due to electrical shorts.

DO NOT SPLICE INTO ELECTRICAL CABLES.

Never cut away cable insulation to supply power to other equipment. Doing so will exceed the current carrying capacity of the wire and result in fire or electric shock.

DO NOT USE BOLTS OR NUTS IN THE BRAKE OR STEERING SYSTEMS TO MAKE GROUND CONNECTIONS.

Bolts or nuts used for the brake or steering systems (or any other safety-related system), or tanks should NEVER be used for installations or ground connections. Using such parts could disable control of the vehicle and cause fire etc.

KEEP SMALL OBJECTS SUCH AS BATTERY OUT OF THE REACH OF CHILDREN.

Swallowing them may result in serious injury. If swallowed, consult a physician immediately.

DO NOT INSTALL IN LOCATIONS WHICH MIGHT HINDER VEHICLE OPERATION, SUCH AS THE STEERING WHEEL OR GEARSHIFT.

Doing so may obstruct forward vision or hamper movement etc. and results in serious accident.

Caution

HAVE THE WIRING AND INSTALLATION DONE BY EXPERTS.

The wiring and installation of this unit requires special technical skill and experience. To ensure safety, always contact the dealer where you purchased this product to have the work done.

USE SPECIFIED ACCESSORY PARTS AND INSTALL THEM SECURELY.

Be sure to use only the specified accessory parts. Use of other than designated parts may damage this unit internally or may not securely install the unit in place. This may cause parts to become loose resulting in hazards or product failure.

ARRANGE THE WIRING SO IT IS NOT CRIMPED OR PINCHED BY A SHARP METAL EDGE.

Route the cables and wiring away from moving parts (like the seat rails) or sharp or pointed edges. This will prevent crimping and damage to the wiring. If wiring passes through a hole in metal, use a rubber grommet to prevent the wire's insulation from being cut by the metal edge of the hole.

DO NOT INSTALL IN LOCATIONS WITH HIGH MOISTURE OR DUST.

Avoid installing the unit in locations with high incidence of moisture or dust. Moisture or dust that penetrates into this unit may result in product failure.

Precautions

- Be sure to disconnect the cable from the (-) battery post before installing your TUE-T252TX. This will reduce any chance of damage to the unit in case of a short-circuit.
- Be sure to connect the color coded leads according to the diagram. Incorrect connections may cause the unit to malfunction or damage the vehicle's electrical system.
- When making connections to the car's electrical system, be aware of the factory installed components (e.g. on-board computer). Do not tap into these leads to provide power for this unit. When connecting the TUE-T252TX to the fuse box, make sure the fuse for the intended circuit of the TUE-T252TX has the appropriate amperage. Failure to do so may result in damage to the unit and/or the vehicle. When in doubt, consult your ALPINE dealer.
- The TUE-T252TX uses female RCA-type jacks for connection to other units (e.g. amplifier) having RCA connectors. You may need an adaptor to connect other units. If so, please contact your authorized ALPINE dealer for assistance.

IMPORTANT

Please record the serial number of your unit in the space provided below and keep it as a permanent record. The serial number plate is located on the bottom of the unit.

SERIAL NUMBER: _____
INSTALLATION DATE: _____
INSTALLATION TECHNICIAN _____
PLACE OF PURCHASE _____

Installation and Connections

Preparation

- 1 Park the vehicle in a flat, safe place. Apply the parking brake, then remove the ignition key.
- 2 Check the included parts and organize the tools and installation instructions.

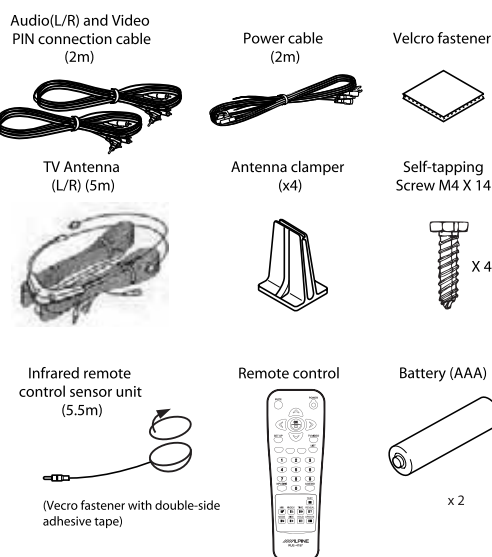

- 3 Disconnect the battery's minus terminal.

Installation

Installing TV TUNER

This TV TUNER can be placed inside the trunk, on the kick panel of the front passenger's seat or underdash. However, to avoid unnecessary signal wiring, it is better to mount the TV TUNER as close as possible to the Display.

DO NOT MOUNT THE UNIT IN LOCATIONS THAT WILL BE IN THE VICINITY OF MOISTURE OR EXTREME HEAT (such as the engine compartment).

Make sure you have all the necessary parts and tools. Then, begin mounting according to one of the following procedures:

Mounting

This installation method is suggested when the mounting location does not permit drilling. USE THIS METHOD ONLY WHEN THE UNIT IS MOUNTED ON A HORIZONTAL SURFACE. NEVER MOUNT A UNIT UPSIDE-DOWN USING THE VELCRO TAPE.

- 1 Remove the adhesive protective paper from one side of the Velcro fasteners.
- 2 Attach the exposed adhesive side to the underside of the unit, in a central location. Do not cover the serial number.
- 3 Make sure the mounting location is clean, dry and free from contaminants.
- 4 Remove the protective strip from the other side of the Velcro pad.
- 5 Press the unit onto its mounting location.

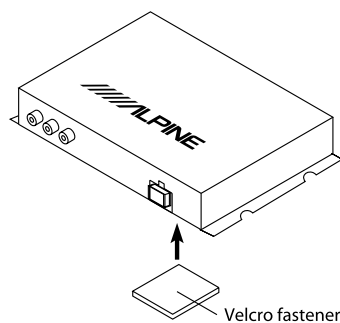

Attaching with screws

1. Place the unit on the location chosen for installation.
2. Mark the screw locations using the unit as a template
3. Drill a hole less than 3mm in diameter.

⚠ WARNING

When you are drilling a hole in the car body, be careful not to damage pipes, tanks or electrical wiring etc.. It might cause an accident or a fire

4. Firmly attach the unit using 4 of the supplied selftapping screws (M4X14)

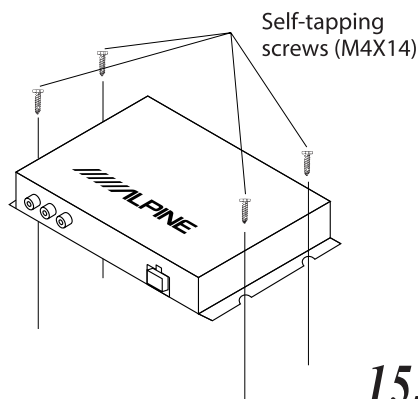

TV Antenna Mounting Method

- 1 Determine the mounting location.
Determine the mounting locations at left and right corners of the rear window. (Fig.1).
- 2 Peel off the base paper and put on the antenna. Clean dirty of the mounting locations, and then put on the antenna.

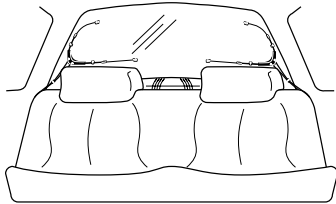

Fig.1

- 3 Pinch the antennas and fix them onto the window panel, by using the attached antenna fixing clamps. (Fig. 2)

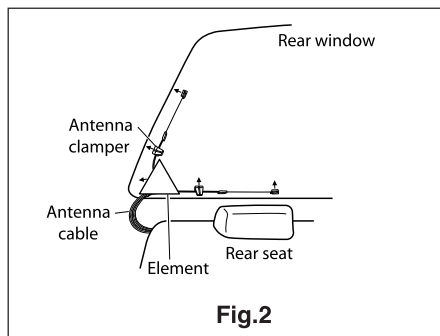

Fig.2

NOTES

- Before put on the antenna, heating the mounting locations with a hair dryer will assure good result.
- Do not apply any humidity and force within 24 hours after putting on the antenna.
- In order to keep the good reception, be sure to put the antenna cable firmly to the body-side of the car (metal part) when wiring it from the element part to the side of the car-room.
- Reception may be a bit worse in the car whose window glasses are of the type not allowing airwaves to go through.

Remote Control Sensor Unit Mounting Method

NOTES

- The remote control sensor unit is used only when operating TUE-T252TX from the rear monitor
- When mounting the unit with double-sided adhesive tape, make sure the mounting surface is dry and free from dirt or grease.

- 1 Take double-sided adhesive tape out on the patched Vecro fastener of the remote control sensor unit.

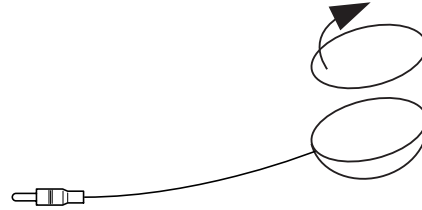

- 2 Before completing the sensor mounting, make sure the location selected is within the operating range of the remote control. Peel off the backing of the adhesive tape and press the sensor onto the selected mounting location, or inside of the remote control holder.

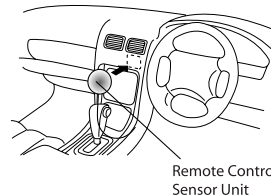

Remote Control Sensor Unit

To prevent external noise from entering the audio system.

- Locate the unit and route the leads at least 10cm a way from the car harness.
- Keep the battery power leads as far away from other leads as possible.
- Connect the ground lead securely to a bare metal spot (remove the coating if necessary) of the car chassis.
- If you add an optional noise suppressor, connect it as far away from the unit as possible. Your Alpine dealer carries various Alpine noise suppressors, contact them for further information.
- Your Alpine dealer knows best about noise prevention measures so consulty our dealer for further inf ormation.

Installation and Connections

Connections and System Wiring Diagram

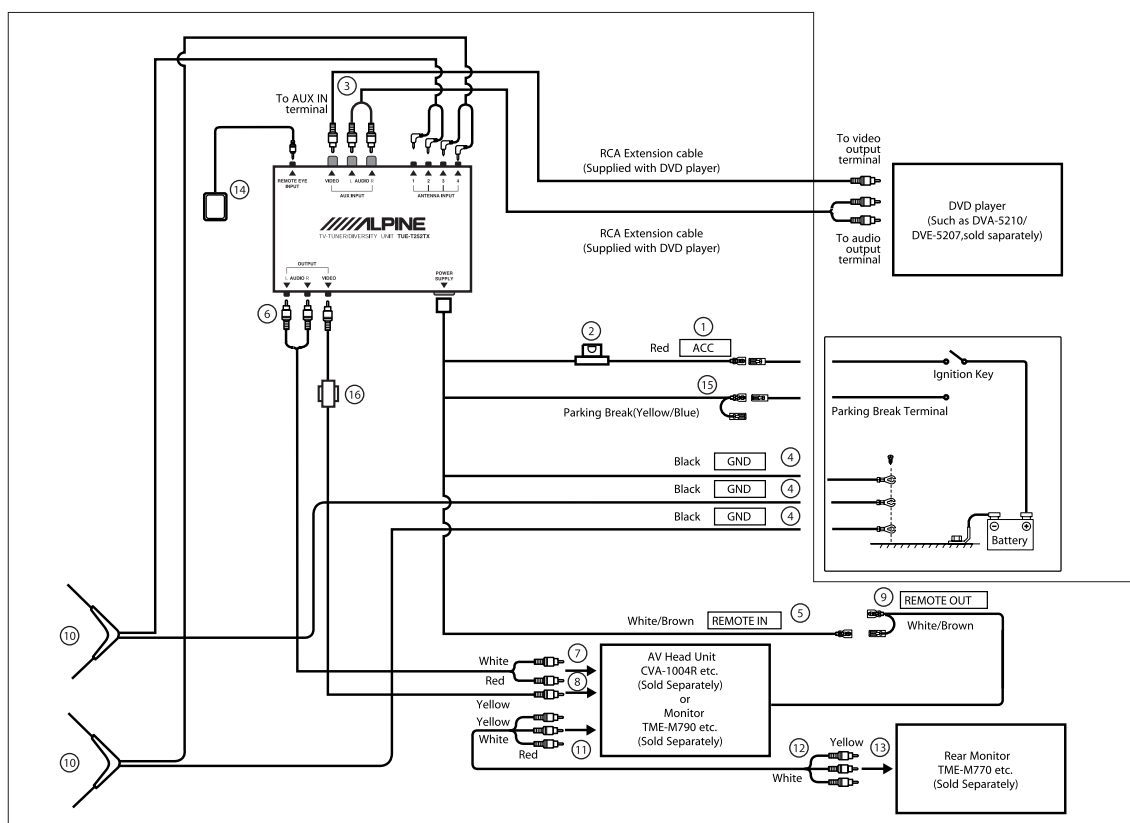

NOTE

Caution - when connecting the Rear Monitor

Make sure to use the Remote Control Eye, when operating TUE-T252TX from the rear monitor. In this case, the signal of the Remote Control Input Lead becomes ineffective.

- ① **Switched Power Lead (Ignition) (Red)**
Connect this lead to an open terminal on the vehicle's fuse box or another unused power source which provides (+) 12V only when the ignition is turned on or in the accessory position.
- ② **Fuse Holder (2A)**
- ③ **Aux Input (Audio & Video input line)**
- ④ **Ground Lead (Black)**
Connect the lead to a good chassis ground on the vehicle. Make sure the connection is made to bare metal and is securely fastened using the sheet metal screw provided.
- ⑤ **Remote Control Input Lead (White/Brown)**
Connect to the remote control output Lead of the CV A-1004R, etc.
When using the remote control eye, the signal of this lead becomes ineffective.
- ⑥ **RCA Extension Cable (Included)**
- ⑦ **To AUX Audio L-ch/R-ch Input Connector**
- ⑧ **To AUX Video Input Connector**
- ⑨ **Remote Control Output Lead**
- ⑩ **TV Antenna (Included)**
- ⑪ **AUX Output Terminal**
Use when connecting an optional monitor.
- ⑫ **RCA Extension Cable (Sold separately)**
- ⑬ **To AUX Input Connector**
- ⑭ **Remote Control Eye**
Make sure to use this when operating TUE-T252TX from the rear monitor.
- ⑮ **Parking Break (Yellow/Blue)**
Connect Parking break signal of vehicle
- ⑯ **Ferrite Clamp**